

It is the responsibility of the installer to meet or exceed all code and safety requirements, and to obtain all required building permits. These instructions are only a guide and may not address every circumstance. The deck and railing installer should determine and implement appropriate installation techniques for each situation. **FAIRWAY Building Products, shall not be held liable for improper or unsafe installations.**

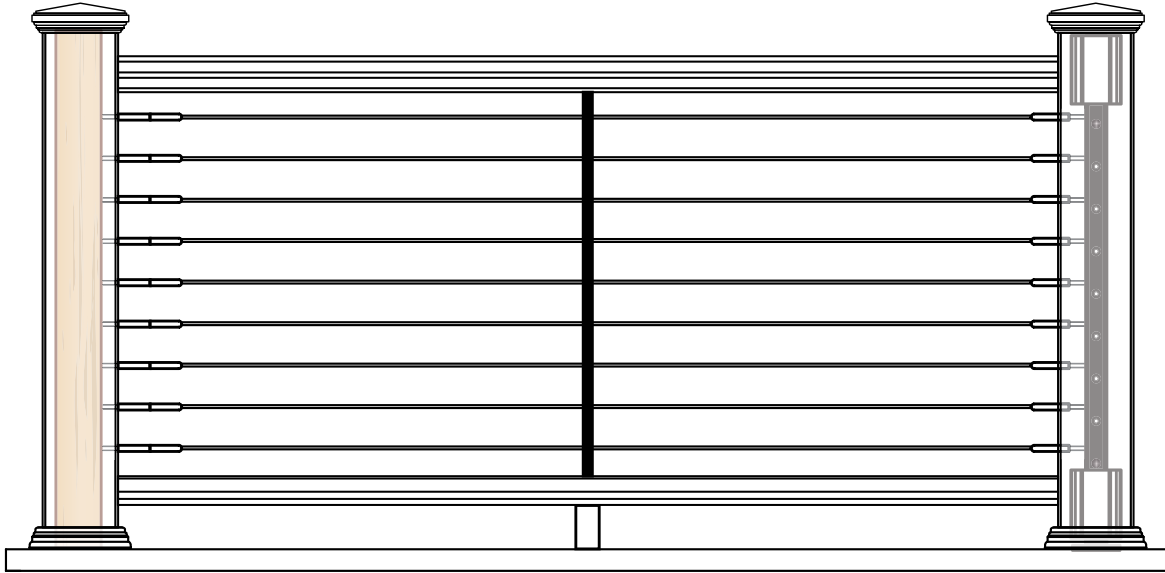

## WOOD POST

Hardware for installing cable railing into wood posts.

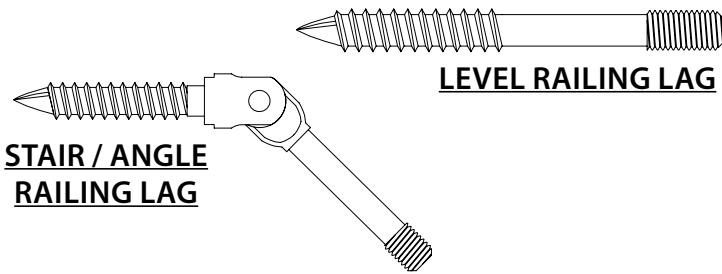

## FD POST

Hardware for installing cable railing into FD POST.

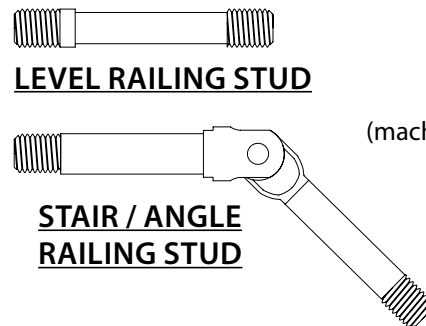

### FD POST MOUNT

- Available in
- Flow-Drilled (machined to receive fittings)
  - Pass-Through (cable passes through)

### CABLE RAILING FITTINGS

#### TENSIONING

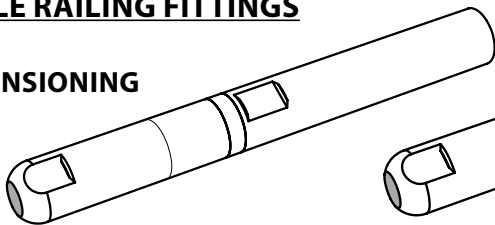

#### NON-TENSIONING

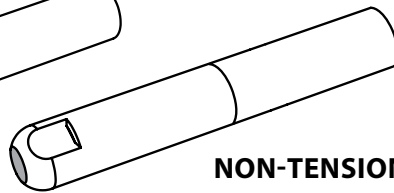

### INTERMEDIATE BALUSTER

Needed every 48" • Sold Separately

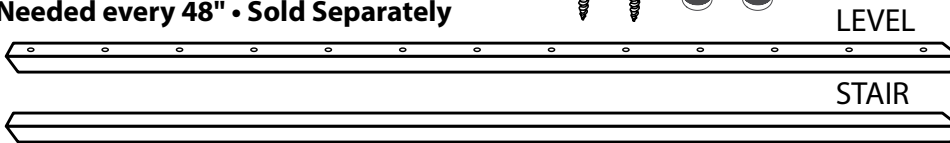

### TOOLS NEEDED FOR INSTALLATION

- Cable Cutter
- 3/16 Hex Head Bit
- Miter Saw
- Drill - set to low speed
- 3/16", 7/32", 7/16" Drill Bits
- (2) High-Quality 3/8" Open End Wrenches
- Tape Measure
- T- Bevel for stair

### CABLE RAILING POST LAYOUT

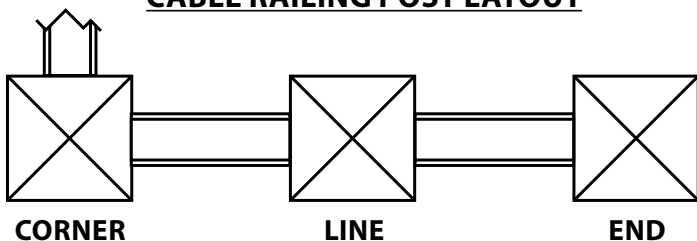

### CABLE RELEASE TOOL -

(Included in tensioning fittings package)

To remove cable slide release tool along cable and into tensioning and / or non-tensioning fitting to open fitting and release cable. NOTE: If cable has been tensioned tensioning fittings should be replaced after cable release tool has been used.

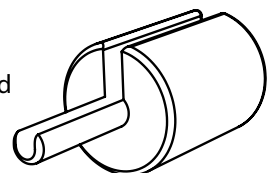

# LEVEL RAILING

## 1 WOOD POST LEVEL RAILING INSTALLATION

1A 1B

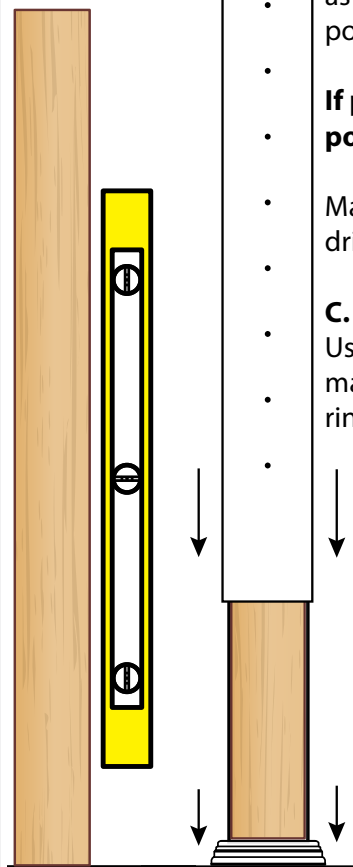

A. Plumb post/mounting surface.

B. Install post trim ring.

• Install pre-drilled post sleeve to use as a drill template for post/mounting surface.

• **If post trim ring has tabs be sure post sleeve rests on tabs.**

• Mark post/mounting surface drill locations.

C. Remove post sleeve.

• Using a 7/32" bit drill pilot holes at marked locations. Slide post trim ring and post sleeve over post.

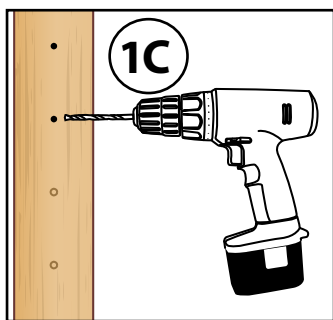

## 1 FD POST LEVEL RAILING INSTALLATION

Plumb post/mounting surface.

Slide base trim ring and post sleeve over post.

**If post trim ring has tabs be sure post sleeve rests on tabs.**

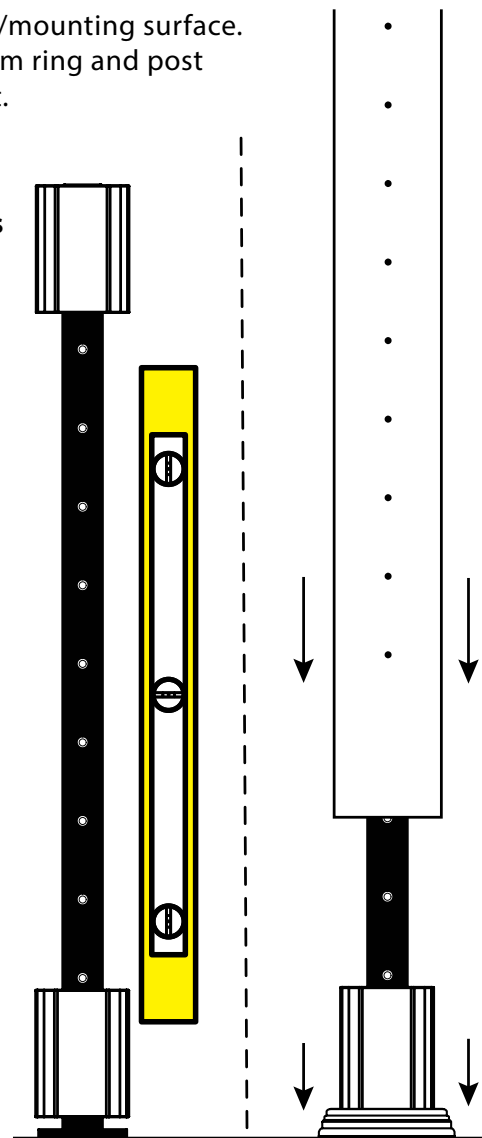

**INSTALL ALL FRAMEWORK (RAILS AND INTERMEDIATE BALUSTERS) BEFORE CABLE AND FITTINGS INSTALLATION MAKE SURE TOP RAILS IS 36" IN HEIGHT OR GREATER**

## 2 Termination (Corner/End)

post sleeves must have pre-routed holes enlarged with a 7/16" drill bit to receive cable railing tensioning fittings.

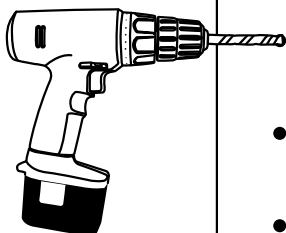

## 3

Measure distance between posts/mounting surfaces.

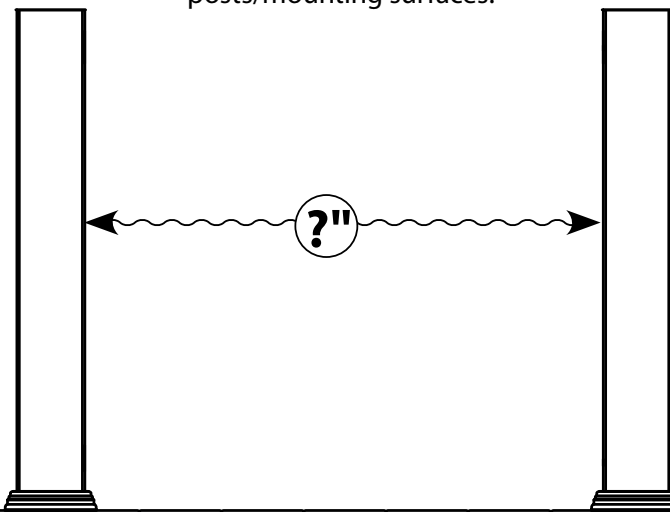

## 4

Refer to railing installation guides. Install bottom rail.

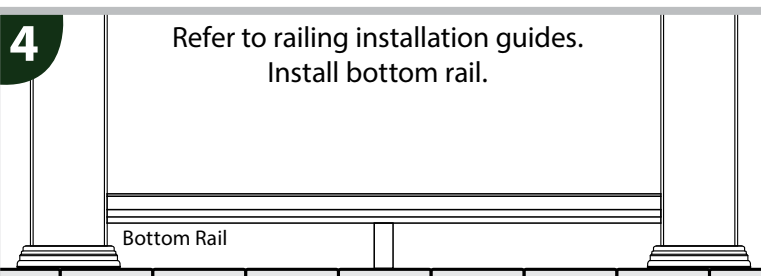

## 5 INTERMEDIATE BALUSTER

### 5A - Determine Intermediate Baluster Length.

Measure from top of bottom rail to bottom of first pre-routed hole on the post sleeve.

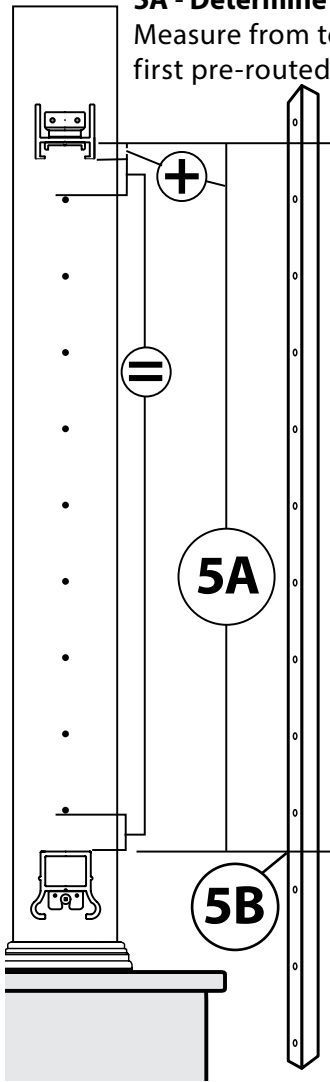

Transfer measurement to above top pre-routed hole in post sleeve. Add distance to bottom of top railing surface.

**5B - Transfer measurement to intermediate baluster. MAKE SURE PILOT HOLES ALINE.** Cut intermediate baluster using a miter saw with a fine tooth carbide blade.

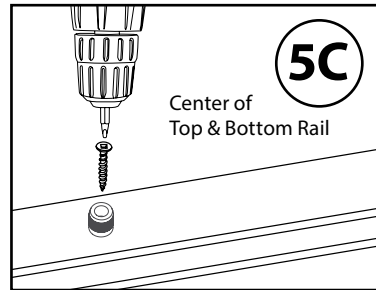

**5C - Install Intermediate Baluster.** Locate center of top and bottom rail. Using supplied hardware install intermediate baluster connectors on top of bottom rail and underside of top rail.

**6** Cut two shims the same length as trimmed intermediate baluster. Install intermediate baluster on connectors from 5C. Install intermediate baluster and top rail as instructed in railing installation guide.

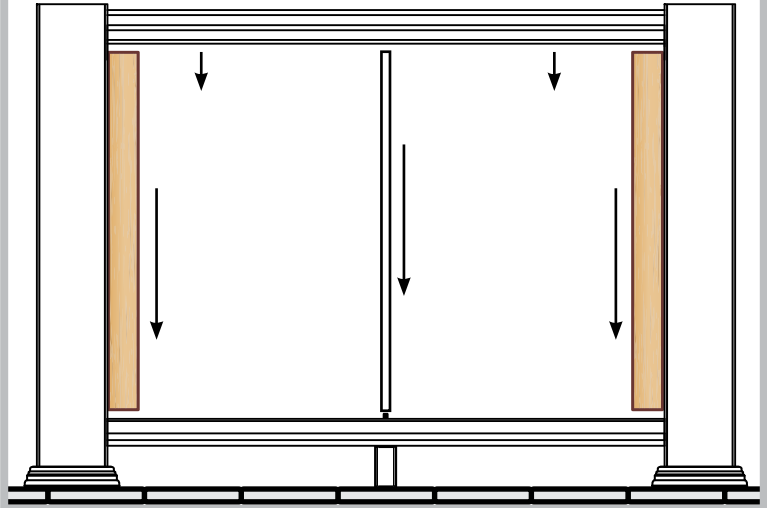

**7 Wood Post** - Insert cable rail lag screws into wood post, then tighten with a 3/16" hex wrench until lag threads are buried in post. **FD Post** - Hand-turn the cable rail stud into the FD Post to start threads, then tighten with a 3/16" hex wrench.

### WOOD POST

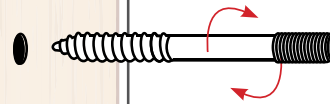

### FD POST

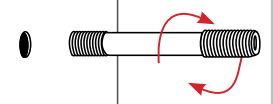

**8 8A** - Install tensioning and non-tensioning cable rail fittings. Insert cable into non-tensioning fittings, run cable through intermediate posts/balusters  
**8B** - Pull cable to tensioning fitting and cut cable with cable cutters at witness line.

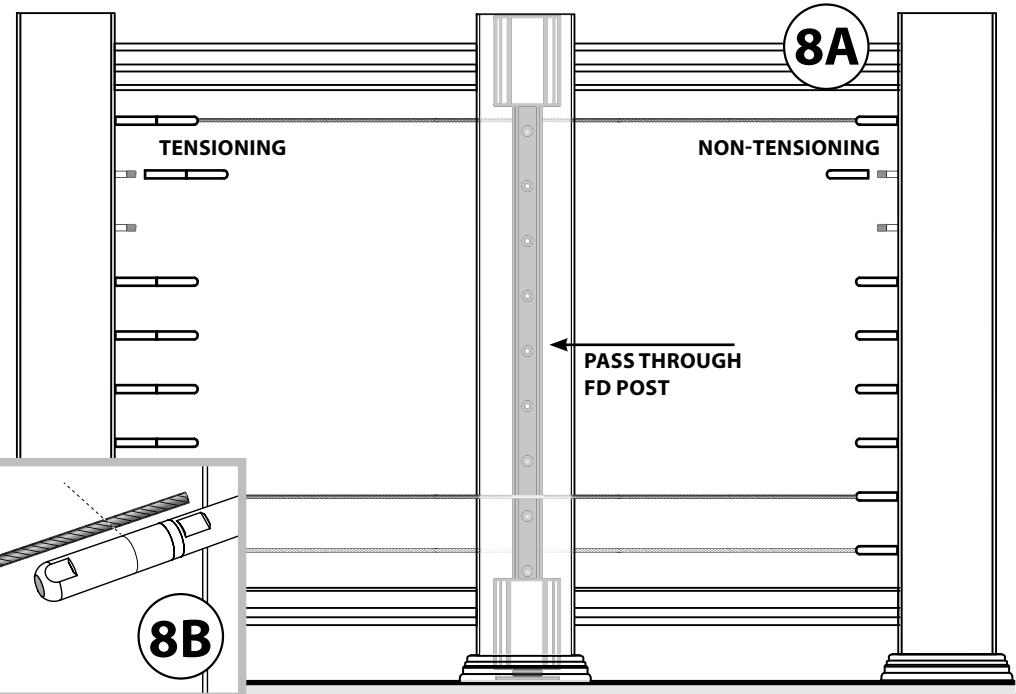

**9** Use high-quality open end wrenches to

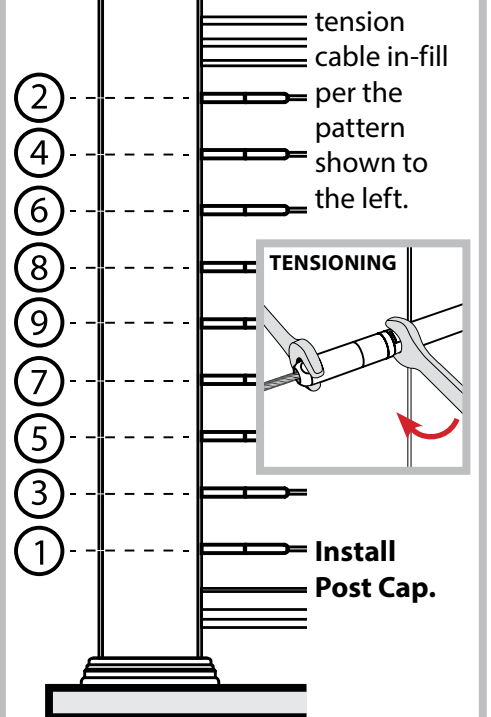

# STAIR RAILING

## 1 FD POST

**AT BOTTOM OF STAIRS** - flip the top block of FD Post to reveal a 10th cable fitting connection.

Remove Lock Screw

Rotate Top Block

Reinstall Lock Screw

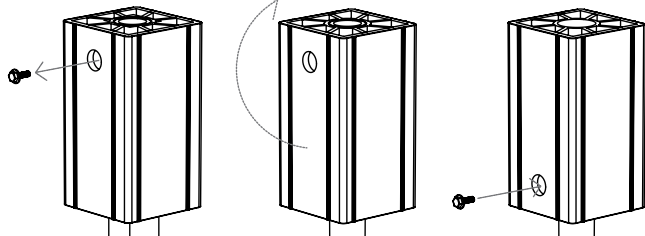
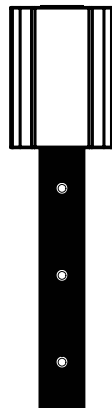

**3 Wood Post** - Insert cable rail lag screws into wood post, and hand tighten using fitting as leverage.

**FD Post** - Insert cable rail machine stud into post, and hand tighten using fitting as leverage.

### WOOD POST

### FD POST

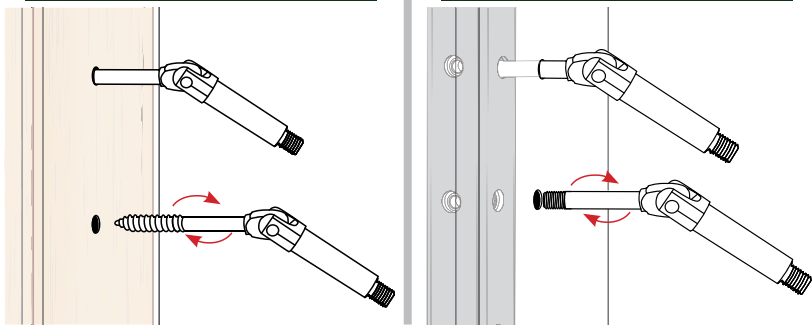

**5 5A** - Install tensioning and non-tensioning cable rail fittings. Insert cable into non-tensioning fittings, run cable through intermediate posts.

**5B** - Pull cable to tensioning fitting and cut cable with cable cutters at witness line. Use high-quality open end wrenches to tension cable in-fill per the pattern shown on previous page.

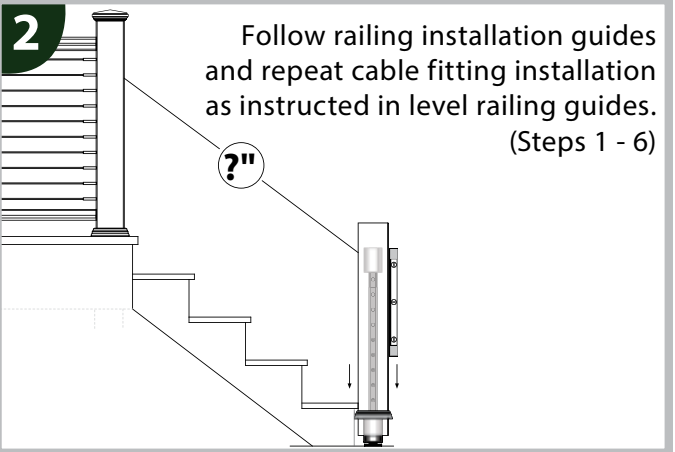
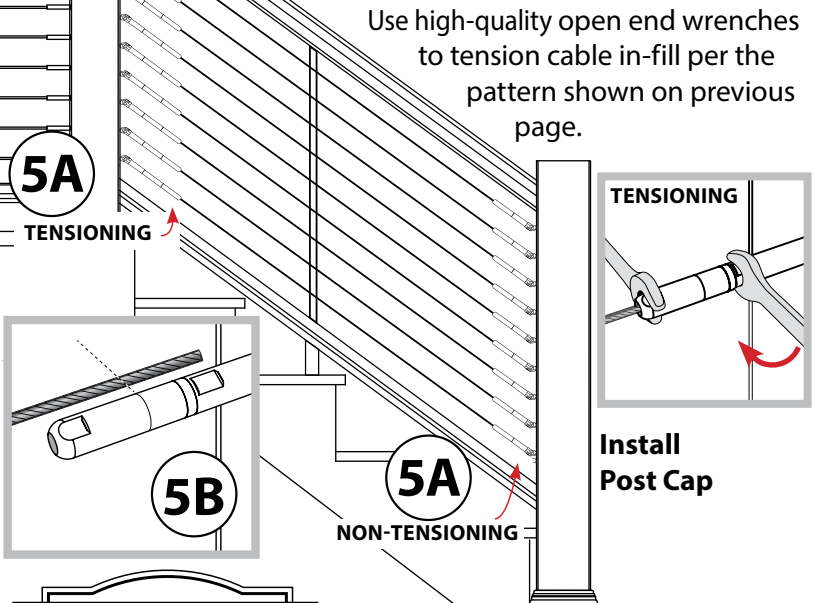

## 4 INTERMEDIATE BALUSTER

### 4A - Determine Intermediate Baluster Length.

Measure from top of bottom rail to bottom of first pre-routed hole on the post sleeve. Transfer measurement to above top pre-routed hole in post sleeve. Add distance to bottom of top railing surface. Subtract 1/4" from your measurement to account for the intermediate baluster connectors.

**4B - Transfer measurement to intermediate baluster.** Use a T-bevel to transfer the stair angle to the intermediate baluster and mark locations of pass through holes and end cuts. Use a 3/16" drill bit to drill pass-through holes spaced 3-1/8" on center. Do not drill straight through.

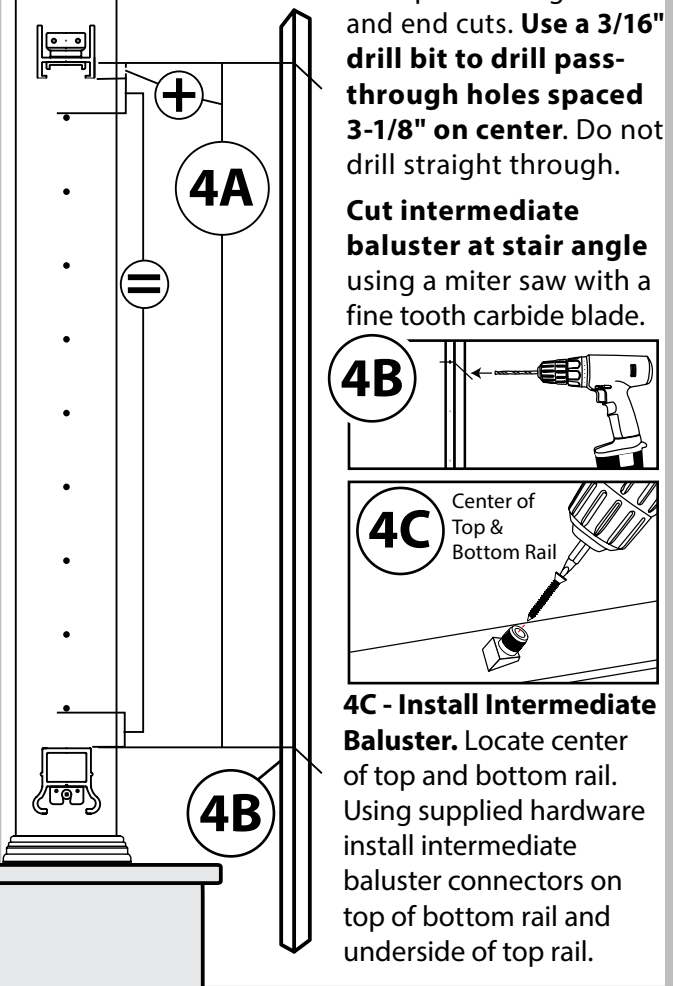

**4C - Install Intermediate Baluster.** Locate center of top and bottom rail. Using supplied hardware install intermediate baluster connectors on top of bottom rail and underside of top rail.



1-800-598-5245 • www.FairwayBP.com

53 Eby Chiques Rd., Mount Joy, PA 17552 • 1914 South Grant Ave., York, NE 68467

# FAIRWAY<sup>®</sup>

## CABLE RAIL SYSTEMS

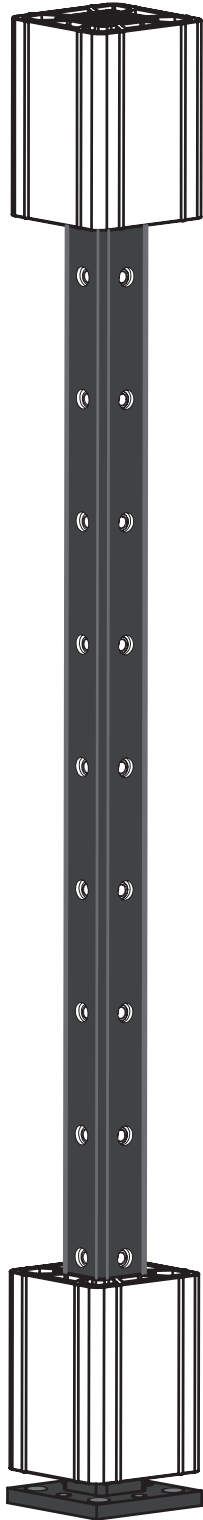

FD Post\*



Flow-Drilled  
Aluminum Insert

### ITEM #201000

## FAIRWAY FD POST

*Top block can be flipped to reveal top hole for stair railing applications*

•

*Bottom block can be removed to reveal bottom hole for installations where no bottom rail is desired*

•

Includes:

*Four (4) 5/16" x 1" Leveling Screws and leveling shims for non-level surface mounting*

\* 4" x 4" x 36" FD Structural Post Mount is coated with an extremely heavy duty, two-layer protective textured finish that is designed and tested to resist corrosion in exterior applications.

Dimensions and tolerances contained on drawings and figures are for reference only and may not encompass total allowable and approved dimensional variations.

DOCUMENT TITLE:		<b>4" x 4" Cable Flow-Drilled FD Post Mount</b>		
This drawing is the property of Fairway Building Products. Any hard copy of this drawing may not be current. This document and/or images contained within may not be reproduced in publication format without express written consent of Fairway Building Products. Drawings may not be to scale.		FAIRWAY VINYL SYSTEMS P.O. Box 37 Mount Joy, Pa 17552		
UCM inch/mm	REF#	PPPP 201000 P1	REV	1
SCALE:	SHEET#	1 of 1	DRAWN BY:	DATE: 5-07-15
			AH	